



White Paper

Energy Storage Battery Safety
in Residential Applications



Content

1	Introduction.....	2
2	Dynamics of battery accidents and thermal runaway as main risk.....	2
3	Reasons for thermal runaway.....	3
3.1	Thermal abuse.....	3
3.2	Mechanical abuse	3
3.3	Electrical abuse	3
4	Best practice	4
4.1	Battery design	4
4.1.1	Cell types: LFP vs. NCM battery	4
4.1.2	Battery model voltage range	4
4.1.3	System design and Installation safety.....	5
4.2	Dynamic battery charging map	5
4.3	Overcharge Protection	6
4.4	Full charge cutoff strategy.....	7
4.5	Thermal management.....	8
4.5.1	Insulation pads between cells	8
4.5.2	High temperature insulation pads between cells and shell casing.....	9
4.5.3	Full coverage temperature detection	9
4.6	Decompression valves.....	10
4.7	Integrated Fire Extinguisher	10
4.8	System protection	11
4.9	Consistency of manufacturing	12
4.10	Safety tests & certifications.....	13
4.10.1	Safety test on battery cell level.....	13
4.10.2	Thermal runaway tests	13
4.11	App-based safety visualization.....	14
5	Summary and outlook	15
	Legal Disclaimer.....	16

1 Introduction

The market for battery energy storage systems (BESS) is experiencing rapid growth, particularly in residential settings. This trend is especially pronounced in countries like Germany, where BESS have swiftly become the standard for residential photovoltaic (PV) applications. In fact, approximately 90% of newly constructed solar PV power plants in Germany now incorporate energy storage systems.

Over recent years, the cost of BESS has significantly decreased while performance has improved. Additionally, as the grid incorporates more fluctuating renewable energy sources, BESS emerge as the primary means to ensure residential users a reliable stream of income from their PV installations.

With the increasing prevalence of installations featuring battery energy storage systems (BESS), a rising number of battery-related incidents are capturing headlines.

The following table shows some examples of battery-related accidents in Germany:

Location	Date	Incident description
Burladingen	Mar 2023	Basement fire
Grefrath	Apr 2023	Basement fire
Ehrenfriedersdorf	Sep 2023	Fire in a residential building
Kochel am See	Sep 2023	Basement fire
Kleinkahl	Sep 2023	Fire and explosion of a BESS
Lauterbach-Wernges	Oct 2023	Destruction of the wall of a residential building
Oststeinbek	Nov 2023	Fire of BESS

Figure 1: Examples of battery-related fires in Germany (source: pv magazine & own research).

Without a doubt, battery safety stands as a paramount concern, particularly among residential customers. Despite a relatively low fire risk of 0.007, apprehensions surrounding safety have tempered the rapid expansion of the energy storage market in numerous countries. Notably, there exists a significant willingness among customers to invest in additional safety features beyond mandated local standards.

This apprehension is deeply intertwined with the fear of potential livelihood losses, especially if insurance coverage fails to adequately compensate for damages. Residential BESS users also express concerns about the possibility of battery incidents occurring during nighttime while they are asleep, potentially resulting in severe health consequences or even fatalities.

The primary objective of this report is to illuminate the safety landscape of BESS and explore technical avenues to mitigate the risk of battery incidents. Of particular concern is the unique risk posed by thermal runaway, wherein temperatures escalate rapidly once initiated, making containment challenging. Following an overview of the thermal runaway phenomenon, subsequent sections delve into the underlying causes of battery failures.

Central to the report is the identification of best practices that surpass the market standard, aimed at elevating battery safety. The goal is to empower professional PV installers and prospective energy storage system customers to assess the incorporation of safety features for BESS available in the marketplace.

2 Dynamics of battery accidents and thermal runaway as main risk

The term "thermal runaway" denotes a perilous phenomenon characterized by highly exothermic reactions, leading to a self-sustaining process that poses potential dangers within batteries when they overheat. Typically initiated by localized temperature spikes due to factors like overcharging or short

circuits, the thermal runaway process intensifies as heat accumulates and battery chemicals undergo gasification, fostering a vicious cycle of escalating temperatures. This rapid escalation can result in the release of stored chemical energy, elevating the risk of the battery reaching extremely high temperatures, with possible outcomes including mechanical rupture, fire, and explosion.

Within the battery industry, discussions on fire safety primarily revolve around single-cell thermal runaway, with core standards such as UL 9540 and UL 9540A focusing on mitigating risks at this level. However, this singular focus overlooks several safety hazards often implicated in battery energy storage system fires. To comprehensively address these risks, it is imperative to shift the analysis to a multiple-cell level, considering the interplay between different cells.

In cases where a single cell experiences thermal runaway, a substantial risk exists – barring adequate precautions – of heat transmission to adjacent cells, potentially creating a "thermal soak" zone, particularly in the absence of isolation between cells. Yet, the scope of energy storage risks extends beyond thermal runaways. A macro-scale analysis is essential to identify the origins of fire risks, encompassing various dimensions, including human and environmental factors, for a comprehensive understanding of the safety landscape.

3 Reasons for thermal runaway

3.1 Thermal abuse

During thermal abuse scenarios, a battery undergoes thermal shock, leading to localized temperatures soaring to dangerously high levels. An incident such as a fire occurring near the BESS could serve as an example of a situation leading to thermal abuse.

3.2 Mechanical abuse

Local damage caused by external mechanical influences, for example through crashes, shocks, or vibration, could release a significant amount of heat, due to the high energy density of lithium-ion batteries, which can cause thermal runaway.

3.3 Electrical abuse

The primary catalyst for thermal runaway in batteries is electrical abuse. This occurs when a battery is subjected to conditions such as overcharging, over-discharging, or external short circuits. These instances of electrical abuse significantly heighten the risk of thermal runaway within the battery system.¹ Even slight battery overcharge can cause lithium dendrites. These dendrites can then lead to lithium plating and internal short circuits.

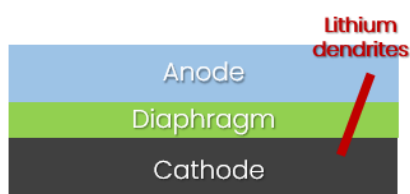

Figure 2: External short circuit inside the battery – © Sigenergy (2024)

Tiny branching structures called dendrites have the potential to breach the separator within battery cells, initiating a chain reaction. Once breached, micro internal circuits generate heat. If this heat is not

¹ <https://www.sciencedirect.com/science/article/pii/S2095495620307075>

effectively dissipated, it can accumulate and, under conditions of substantial overcharging, trigger a thermal runaway.

Several factors contribute to battery overcharge, including inconsistencies among batteries, malfunctioning charge controls, and inadequate battery management practices. While minor instances of overcharging may not immediately lead to thermal runaway, they can degrade battery performance over time, potentially reducing capacity to zero and causing failure.

External short circuits, often caused by wire breakage or water ingress, pose another risk. These short circuits introduce high currents to the cells, elevating temperatures significantly. Moreover, there's a notable risk of electrolyte vaporization due to the high current, leading to volume expansion within the battery casing. If the casing fails under this pressure, it can exacerbate the situation, potentially culminating in thermal runaway and its associated hazards.

4 Best practice

4.1 Battery design

4.1.1 Cell types: LFP vs. NCM battery

Various battery chemistries exhibit distinct characteristics in terms of safety. One notable subgroup of lithium-ion (Li-ion) batteries, nickel cobalt manganese (NCM) batteries, employs a cathode material comprising lithium, nickel, cobalt, and manganese oxide (LiNiMnCoO₂). Another subgroup, lithium ferrophosphate (LFP) batteries, features lithium iron phosphate as the cathode material.

From a safety standpoint, NCM batteries present a higher susceptibility to thermal runaway and associated safety concerns, particularly when subjected to damage or overcharging. The chemical elements nickel, cobalt, and manganese exhibit greater reactivity and lower thermal runaway thresholds, with chemical reactions occurring within the battery at temperatures as low as 200°C. These reactions can produce oxygen, exacerbating fire risks and potentially leading to explosions.

In contrast, LiFePO₄ batteries are renowned for their superior safety features. Their chemistry is more stable, rendering them less susceptible to overheating and overall less hazardous compared to most other lithium-ion batteries.

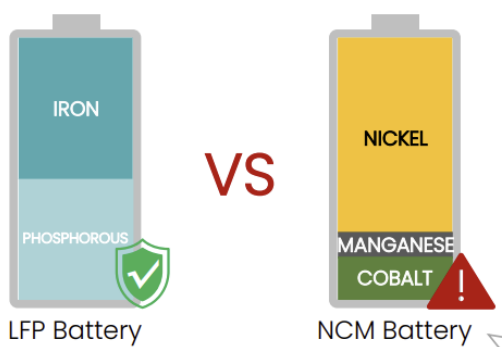

Figure 2: Differences in chemical composition between LFP battery and NCM battery – © Sigenergy (2024)

4.1.2 Battery model voltage range

The use of larger cells means that less cells are needed to form a battery pack of the same size. For example, the SigenStor BAT 8.0 consists of 9 cells à 3.65 V and 280Ah for a battery pack of 8kWh. Therefore, the total voltage is just 32.85V, which is lower than the human safety voltage threshold of 36V. This makes the battery pack safer in operations & maintenance (O&M).

Other manufacturers need 25 x 100Ah cells to form an 8kWh battery pack, so the voltage of the whole system is as high as 91.25V, which makes it more dangerous for O&M, or when replacing the battery pack.

4.1.3 System design and Installation safety

During the installation process, there is a relatively high risk for making severe mistakes that could even happen to experienced electricians. That is why the installation should be as easy as possible.



Figure 3: Quick connector between different Sigenergy modules for quick and easy installation – © Sigenergy (2024)

Best practice regarding the installation of battery energy storage systems and the other components comes from Sigenergy with their stackable connection approach. No external wiring is needed between the modules – data lines and power lines are integrated. Stability is guaranteed through floating screws that are capable of automatic alignment and insertion within $\pm 2\text{mm}$.

This solution avoids safety risks caused by aging, damage and increased contact resistance of external wires, as well as risks of short circuit during wiring installation.

4.2 Dynamic battery charging map

The charging process can also make a difference when it comes to avoiding overcharging. Normally, charging power is only based on temperature. The charging rate does not take into account the “State of Health” (SOH) of the battery. The better its SOH is, the higher the charging current might be without damaging the battery.

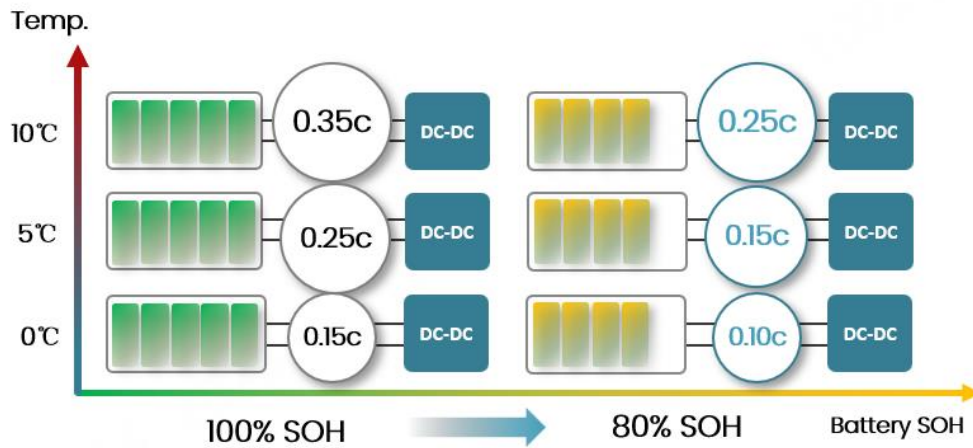

Figure 4: Dynamic battery charging map – © Sigenergy (2024)

This is why battery safety leaders such as Sigenergy have developed a dynamic charging map, which is a 2-dimensional matrix that determines the charging current based on temperature and SOH of the battery. This leads to a better balance of the charging power, preventing overcharge and lithium deposition.

4.3 Overcharge Protection

In the burgeoning landscape of battery energy storage systems, a prevailing concern looms large: the reliance on software-driven overcharge protection. Amidst a multitude of providers, many offer solutions where safeguarding against overcharging hinges primarily on intricate software algorithms. These systems typically deploy an analog front-end chip, a pivotal component enabling the battery management system to meticulously gather cell data and execute the pivotal task of regulating charging and discharging cycles for individual cells. Yet, the efficacy of this safeguard critically hinges on the flawless operation of the underlying software infrastructure.

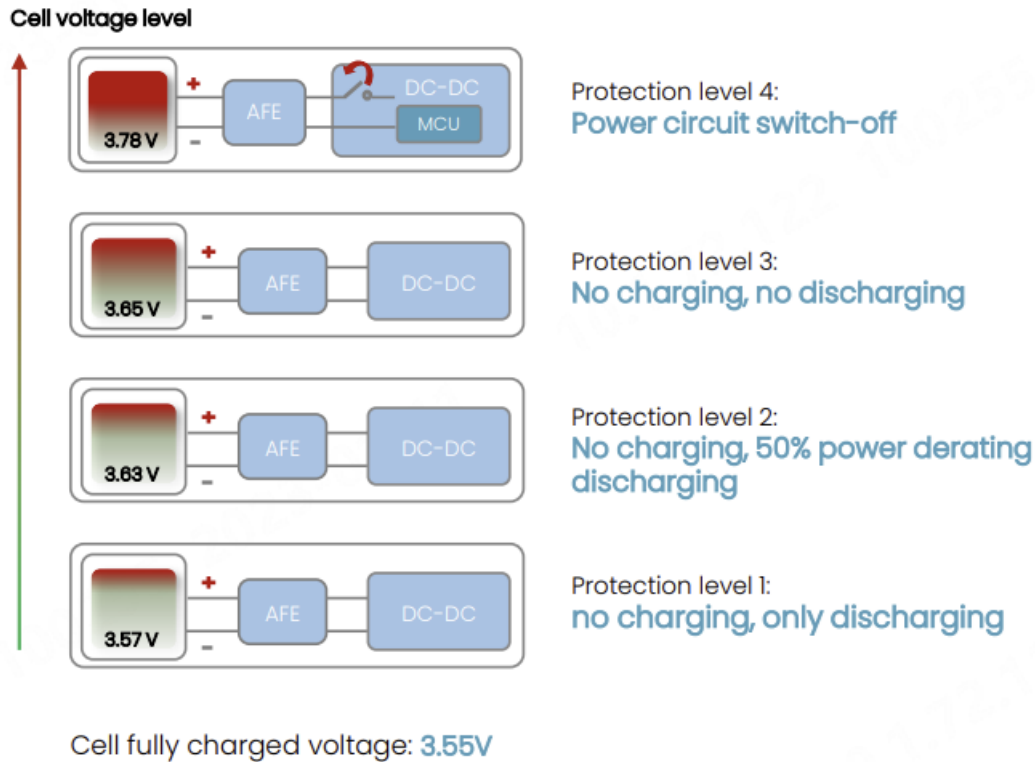

Figure 5: Different levels of overcharge protection – © Sigenergy (2024)

Battery safety leaders such as Sigenergy have added an additional a purely hardware-based protection level that can switch off the power circuit completely when a certain critical cell voltage level has been reached. This protection strategy is completely independent from the battery management system – so it is not prone to software failures.

4.4 Full charge cutoff strategy

A sophisticated charge cutoff strategy can prevent safety issues and also expand the battery life. Systems without overcharging protection risk that a short circuit is caused and might result in a thermal runaway.

In a floating charging strategy, the battery remains in a high state of charge (SOC) which accelerates its lifespan decay, which could also cause in extreme situations safety incidents.

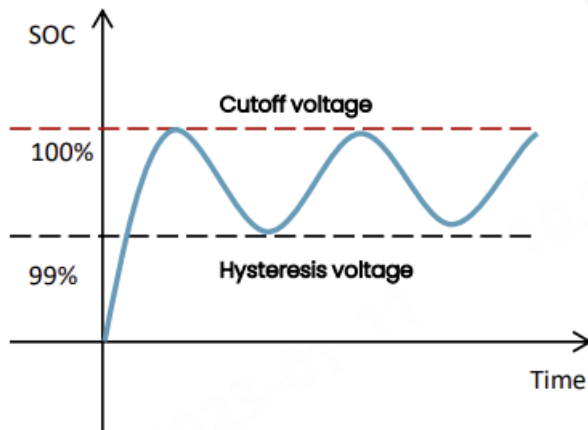

Figure 6: Floating charging strategy – © Sigenergy (2024)

A more sophisticated strategy consists in setting the cutoff-voltage to 100% SOC and define a lower charging boundary (hysteresis voltage) at 99% state of charge. This does not only reduce stand-by losses but also maximizes the lifetime of the battery and minimizes the risks of safety incidents.

4.5 Thermal management

4.5.1 Insulation pads between cells

Insulation pads can prevent a thermal spread between cells. The market standard is to reduce costs and not to maximize battery safety by adding insulation pads.

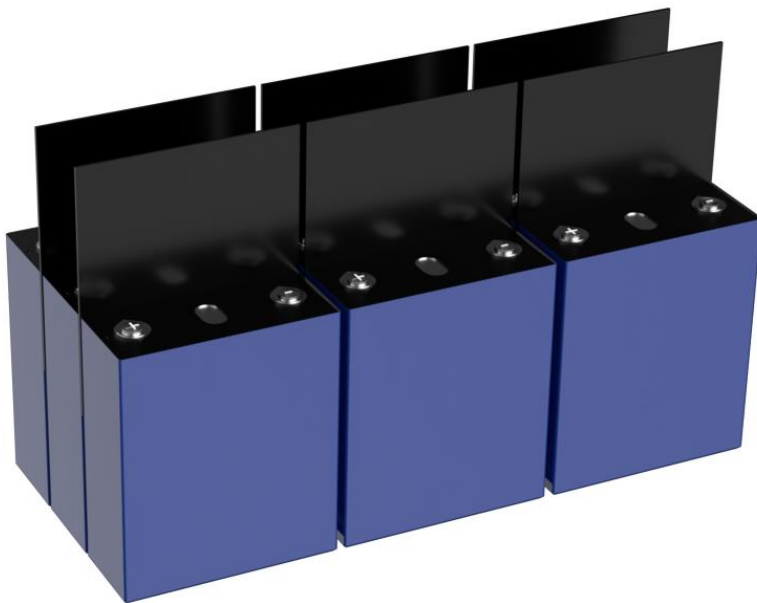

Figure 7: Nine battery cells with six aerogel insulation pads – © Sigenergy (2024)

Sigenergy goes the safe way and uses high-quality aerogel insulation pads to separate the cells. They use an aerogel composite material as the core, and Polymer (PET, PI) films or flame-retardant coatings as packaging materials for the aerogel. This solution comes with the following advantages:

- Low thermal conductivity ($\leq 0.035\text{W/m}\cdot\text{K}$)
- A-grade fire resistance

- Good cushioning effect
- Excellent insulation capacity (between cells up to a difference of 450°C at 700°C)
- Light weight, space saving

4.5.2 High temperature insulation pads between cells and shell casing

The shell casing can be protected from risks that come from cells by adding high temperature insulated pads between cells and shell casing. They prevent electrical leak and thermal spread to the shell casing.



Figure 8: High temperature insulated pad – © Sigenergy (2024)

The insulated pads prevent eliminate insulation problems caused by particles squeezing the battery cells during the production process. They also prevent cell inflation, metal extrusion, further spread of fire under high temperature conditions, and electrical breakdown caused by insulation failure.

The insulated pads that Sigenergy uses have an excellent insulation performance from -40°C to 200°C. Their thermal conductivity is below 0.5 W/m·K, and their insulation impedance is bigger than 500 MΩ (DC 1000V).

4.5.3 Full coverage temperature detection

Many manufacturers still try to reduce battery costs by just using a minimum number of temperature sensors, often just 2-3 per battery module for more than 20 battery cells. This temperature sensor layout cannot fully grasp the cell temperature, or even obtain the highest and lowest cell temperatures, resulting in over-temperature of individual cells in the module, leading to safety risks for the entire system.

Battery safety leaders use more temperature sensors that ensure that each cell and also the DC-DC side can be monitored. Sigenergy uses 7 temperature sensors for 9 battery cells in an 8-kWh battery pack. These 7 sensors enable a comprehensive temperature detection that can fully monitor the operating temperature of each cell.

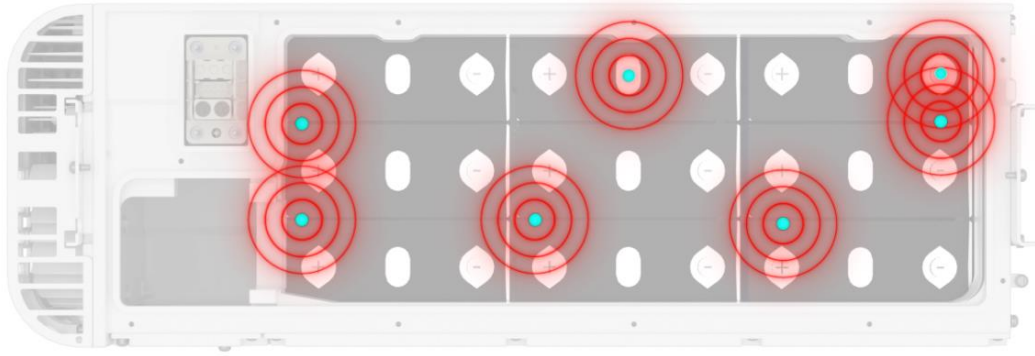

Figure 9: Seven temperature sensors for nine battery cells – © Sigenergy (2024)

This comprehensive temperature detection approach can reduce the risk of battery incidents significantly.

4.6 Decompression valves

Another cutting-edge approach to reduce prevent the explosion of battery packs is the use of innovative decompression valves. These mechanisms reduce pressure within the battery pack structure by discharging combustible gases.

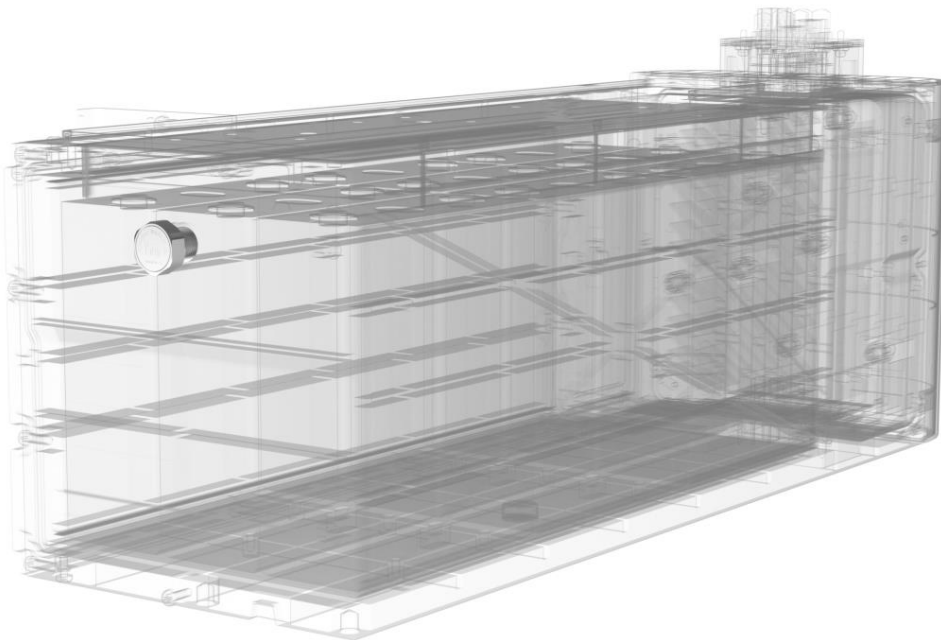

Figure 10: An innovative decompression valve for pressure relief within the battery pack – © Sigenergy (2024)

Most of the providers do not integrate compression valves battery energy storage systems. The correct tuning is very important as if the valve is tuned to low, vapor gets in too easily.

The battery safety leader, Sigenergy, is one of the very few providers that do use an innovative compression valve to reduce the explosion risk of its battery system substantially.

4.7 Integrated Fire Extinguisher

As a last resort, in case the thermal runaway process has already started, and temperatures rise rapidly within milliseconds, an integrated fire extinguisher is issued.



Figure 11: Fire extinguisher integrated outside the battery shell casing – © Sigenergy (2024)

The requirements of modern fire protection are: early suppression, rapid response, and efficient fire extinguishing. For energy storage systems, it is necessary to consider pertinence, and the selected fire extinguishing agent should be suitable for the protected battery.

Sigenergy translates these requirements into action as their system is activated by high temperatures. Thermal sensitive wires trigger the extinguisher at 170°C which involves the extinguisher itself injecting 40g of aerosol that absorbs heat and free radicals to extinguish the fire within 4 seconds.

Surprisingly, not all manufacturers have integrated a fire extinguisher into their batteries.

4.8 System protection

The BESS is part of a system consisting of a PV array, inverters, and sometimes also an EV charger. Several measures should be applied on a system level.



Figure 12: The complete 5-in-1 SigenStor system – © Sigenenergy (2024)

The 5-in-1 solution “SigenStor” from Sigenenergy comes with the following key system protection features:

- **DC ground-fault protection:** A short circuit of the DC ground line may damage the inverter. DC ground-fault protection can cut off a faulty circuit spread in time.
- **Arc fault circuit interruption:** Instantly detects and protects to ensure safety in PV systems, preventing fires coming from high arc temperature.
- **PV disconnection protection:** When the inverter has a potential fault, SigenStor will automatically disconnect from the PV system to prevent any PV energy input which may present a significant risk.
- **Grid fault protection:** A miniature circuit breaker is deployed between the energy gateway and the grid; it can cut off the energy input from the grid when some problem occurs.
- **DC bus protection:** There is a DC bus between each SigenStor module to transfer power. DC bus protection can cut off a faulty circuit spread between the different modules of SigenStor.

4.9 Consistency of manufacturing

High and consistent manufacturing quality is important to minimize the risks that could come from batteries. E.g., some battery incidents were caused by welding burr from metal contaminant particles in the manufacturing. The welding burr had punctured the insulation tape between cells which led to direct reactions between the positive and negative electrodes.

Between different manufacturers there are significant differences in the manufacturing process. Consistency can be insured when certain tests are directly incorporated in the manufacturing process.

Sigenenergy highlights its use of advanced equipment to ensure product design consistency and has disclosed the following process steps:

- **Cell thickness measurement:** The measurement accuracy is 0.02 mm, and the thickness control is $\pm 1\text{mm}$

- **Open-circuit voltage (OCV) testing:** Automatic tests of the voltage, AC impedance and voltage drop K value of cells. A manufacturing execution system (MES) automatically determines the results and conducts 100% OCV testing. Voltage difference control: $\leq 5\text{mV}$, resistance difference control: $\leq 0.1\text{m}\Omega$.
- **Polarity detection:** Polarity check of all battery cells to prevent short circuits.
- **Pole addressing:** In cases of incorrect polarity, an addressing mechanism automatically corrects the orientation of the component.
- **Pole laser cleaning:** Cleaning of all poles to reduce welding defect rate.
- **Cell contacting system (CCS) welding:** Including low splashing, improving welding yield through annular light spot, nitrogen protection to prevent weld oxidation, and metallographic/tensile inspections.
- **Safety test:** Product, leakage current control $\leq 4\text{ mA}$.
- **End-Of-Line (EOL) test:** Functional product testing (cell piezoelectric/temperature/function), voltage difference control: $\leq 5\text{mV}$, temperature difference control: $\leq 1\text{ }^\circ\text{C}$.
- **Leak test:** Airtightness testing - the leakage value is controlled to be $\leq 50\text{ Pa}$.
- **Capacity test on a system level:** Inverter-based pack capacity testing, simulating customer on-site usage scenarios, 100% capacity testing, control of charge and discharge terminal voltage difference $\leq 200\text{mV}$, capacity $\geq 280\text{Ah}$.

This consistency-focused manufacturing process goes well beyond the industry standard and prevents many overheating issues that otherwise could cause thermal runaway.

4.10 Safety tests & certifications

4.10.1 Safety test on battery cell level

The IEC 62619 certification contains numerous tests:

- External short circuit test
- Thermal abuse test
- Drop test
- Internal short circuit test
- Overcharge test
- Impact test

4.10.2 Thermal runaway tests

Regarding thermal runaway test on both cell and battery pack level, UL9540A gives additional insights that are not required under IEC 62619 certification. Even if UL is only mandatory in the US market, the certification gives additional comfort to European users.

UL9540A first determines the thermal runaway temperature of the cell, and then compares it to the thermal runaway temperature of the battery pack.

Clause	Requirement + Test	Result - Remark	Verdict
	Location of cells forced into thermal runaway were selected to present greatest thermal exposure to adjacent cell.	See attachment 2 for details.	P
	Factors consider when selecting location of cells inside module:	<input checked="" type="checkbox"/> Heat transfer was maximized to other cells. <input checked="" type="checkbox"/> Cooling by ventilation was restricted or limited. <input type="checkbox"/> Thermal sensors, detection and suppression discharge points were remote. <input type="checkbox"/> Other(explain):	P
8.2.5	Method used to initiate thermal runaway during cell level was used at the module level of testing	Confirmed	P
8.2.6	Occurrence of thermal runaway was verified by sustained temperature above the cell surface temperature at the onset of thermal runaway.	Confirmed	P
8.2.7	Module was placed on top of a noncombustible horizontal surface	Confirmed	P
	Module orientation was representative of its intended final installation	Confirmed	P
8.2.8	Chemical heat release rate of the module in thermal runaway was measured with oxygen consumption calorimetry	Confirmed	P
8.2.9	Chemical heat release rate was measured for the duration of the test	Confirmed	P
8.2.10	Equipment used for chemical heat release rate measurement:	<input checked="" type="checkbox"/> Paramagnetic oxygen analyzer <input checked="" type="checkbox"/> Non-dispersive infrared carbon dioxide analyzer <input checked="" type="checkbox"/> Non-dispersive infrared carbon monoxide analyzer <input checked="" type="checkbox"/> velocity probe <input checked="" type="checkbox"/> Type K thermocouple <input type="checkbox"/> Other(explain):	P
	The instrumentation was located in the exhaust duct.	Confirmed	P
8.2.11	Heat release rate was calculated as per following formula.	Confirmed	P

The additional safety measures that Sigenergy has incorporate become visible in the UL testing. On cell-level, cell venting, and thermal runaway were observed, however no evidence of fire.

Performance Unit Level Test (Residential Indoor Floor Mounted) (Residential Indoor Wall Mounted)		
Requirement	Comments	Verdict
Flaming outside the initiating BESS unit is not observed as demonstrated by no flaming or charring of the cheesecloth indicator;	No flaming or charring of the cheesecloth indicator	P
Surface temperatures of modules within the target BESS units adjacent to the initiating BESS unit do not exceed the temperature at which thermally initiated cell venting occurs	Surface temperature measured on target units didn't exceed the temperature at which thermally initiated cell venting occurs which is 218.1°C	P
For BESS units intended for installation in locations with combustible constructions, surface temperature measurements on wall surfaces do not exceed 97°C (175°F) of temperature rise above ambient	BESS surface temperature measurements on wall surfaces 103.4°C do not exceed 97°C (175°F) of temperature rise above ambient	P
Explosion hazards are not observed, including deflagration, detonation or accumulation (to within the flammability limits in an amount that can cause a deflagration) of battery vent gases	Explosion or deflagration hazards of vented gas was not observed.	P
The concentration of flammable gas does not exceed 25% LFL in air for the smallest specified room installation size.	The gas collection data gathered was compared to the smallest room installation 140m ³ specified by the manufacturer.	P

4.11 App-based safety visualization

In today's digital age, mobile applications serve as indispensable tools for integrating crucial safety information. For example, the Sigenergy App is a cutting-edge platform that monitors the status of battery cells in real-time. Through its user-friendly interface, this innovative app not only swiftly identifies any abnormal cell behavior but also offers up-to-the-minute data on system operations. This is not only valuable for residential homeowners, but it also serves as a powerful resource for PV installers. With the ability to remotely diagnose the health of energy storage systems, installers can

swiftly pinpoint any issues and ensure optimal performance from afar, revolutionizing the way we approach safety and maintenance in the renewable energy sector.

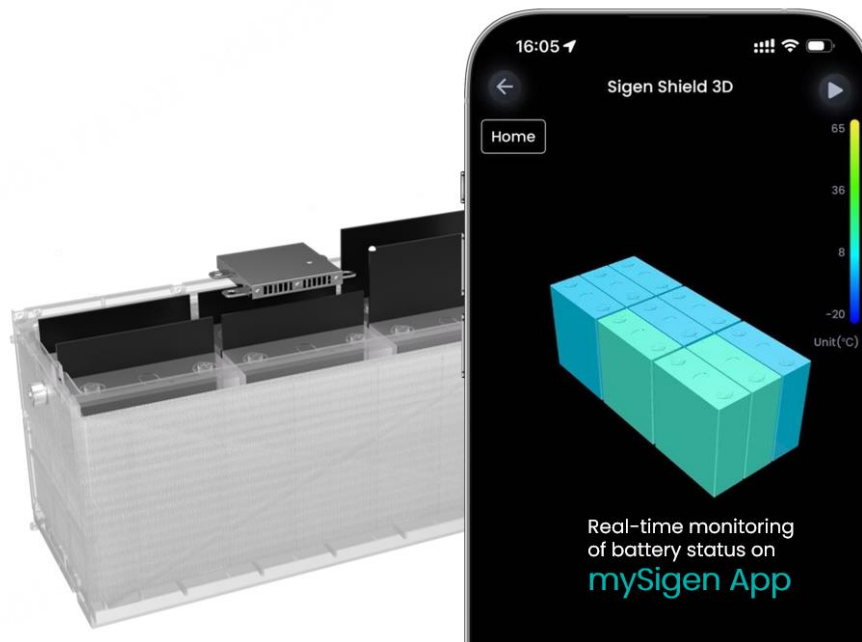

5 Summary and outlook

The report delineates crucial measures aimed at enhancing battery safety and rebuilding the confidence of prospective customers in battery energy storage systems (BESS). It highlights a concerning trend where many manufacturers prioritize cost optimization over battery safety. While norms and certifications establish a baseline market standard, it is evident that this standard falls short of meeting the highest safety standards, particularly for residential applications where customers are exceptionally vigilant in mitigating potential BESS hazards, given that their well-being and livelihoods are on the line.

This report serves as a valuable tool for installers and potential BESS customers seeking to evaluate different energy storage solutions based on their incorporated safety features. Many customers demand more than just meeting the market standard and are willing to invest in additional safety features.

Moreover, norms, standards, and certifications are not immutable. As more BESS providers adopt the recommended safety measures outlined in this report, it could drive the need for stricter regulations and certifications. Experts concur that concerns about BESS safety are hindering the growth of the battery energy storage market. Therefore, it's imperative for battery safety leaders like Sigenenergy to develop enhanced solutions that align with the safety expectations of this critical customer segment.

By publicly offering these advancements and sharing insights gleaned from extensive testing and remote monitoring of real-world applications, other market players will face pressure to follow Sigenenergy's suit. Ultimately, the entire BESS market stands to benefit from the described safety enhancements.

Legal Disclaimer

This report is intended to provide general information current as of the time of its production. The information contained herein is not to be construed as advice and should not be relied upon as such. Prior to taking any action based on the information contained in this study, individuals should seek professional advice. Dr. Thomas Hillig Energy Consulting and Sigenergy hereby disclaim all responsibility and liability, including but not limited to any direct, indirect, or consequential costs, losses, or damages, including loss of profits, arising from any action taken or omitted to be taken by any party in reliance, whether wholly or partially, on any of the information provided. Any party relying on the information does so at its own risk.

The observations and comments included in this document are compiled or derived from information obtained from the industry and publicly available data. This information and data are believed to be reliable and provided in good faith. However, we do not guarantee the completeness or accuracy of such information or verify any of it.

About Sigenergy

Sigenergy, founded in 2022 by industry pioneer Tony Xu, focuses on developing cutting-edge home and business energy solutions, with products ranging from energy storage systems to solar inverters and EV chargers. Sigenergy's world-class R&D team of hundreds of top industry experts shares the vision of making the world greener via continuous innovation. With global sales and services, it aims to become its customers' most trusted partner on their journey to a more sustainable future.

About THEnergy

THEnergy is a boutique consultancy established in 2013 that focusses on innovation in the energy space such as hydrogen, battery energy storage, microgrids, e-mobility and digitalization – helping companies with market entry and growth strategies. For industrial companies, THEnergy develops energy concepts and shows how to become more sustainable combining experience from conventional and renewable energy with industry knowledge in consulting. THEnergy also advises investors and energy companies regarding renewable energy opportunities in rapidly changing markets. The consulting firm has successfully completed several large-scale due diligences.

© THEnergy & Sigenergy (2024)